

FUJIFILM

4400

ELECTRONIC VIDEO ENDOSCOPY SYSTEM

500 SERIES SCOPE

FUJINON VIDEO ENDOSCOPES

500 SERIES SCOPE & 4400 SYSTEM A SOLUTION FOR IMPROVED NEXT GENERATION ENDOSCOPY REALIZED BY FULLY DIGITAL TECHNOLOGY

With advanced total solutions, FUJINON is ready to fulfill a broad range of on-the-scene needs in the endoscopic diagnosis.

500 SERIES SCOPE features leading-edge optical technologies to provide clear, bright endoscopic images for easier and more accurate diagnosis.

It is also kind to users with its grip ergonomically designed for extremely smooth handling.

The fully digital processor 4400 SYSTEM employs state-of-the-art digital signal processing.

This system, compatible with FICE, the image processing function to improve image visibility, takes the fullest advantage of being fully digital.

Fujinon's endoscopy system is a total solution to support image input, processing and sharing, surely contributing to more efficient endoscopy from now on with its excellent performance.



*The appearance of the cart varies depending on the sales area.



Fits right. Moves agilely. Light-weight grip for high operability.

The newly developed grip fits gently into your hand, allowing full use of this high-performance endoscope. Materials, processing, and choice of parts have all been reviewed to reduce the grip weight for greater maneuverability.

The design is improved also to allow easier cleaning and disinfection.

G-5 GRIP and 500 SERIES SCOPE in combination offer you added amenity in routine diagnosis.



500
SERIES
SCOPE

G-5[™]
ENDOSCOPY

Designed Lighter & Slimmer

20% less in weight and 10mm slimmer than that of our conventional product.

The angle operation knob is remodeled to accommodate the fingers more firmly with better fit.

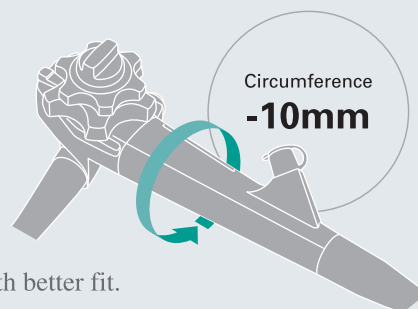

Improved Operability

New positioning of the functional switches, Air/Water and Suction buttons minimizes finger travel and improves efficiency.

VTR & Printer button

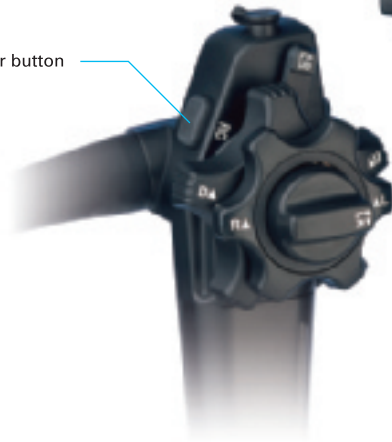

Electronic Magnification button

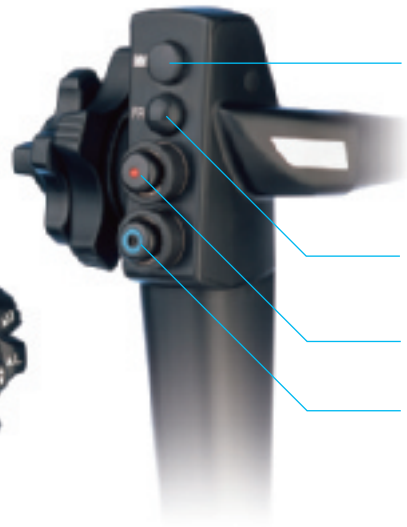

Freeze/ Hard Copy button

Suction button

Air/Water button

Water Jet Function

Main endoscopes for the lower gastrointestinal tract have a water jet nozzle in addition to the forceps channel. Mucus is effectively removed for a clear view of the surface being examined.

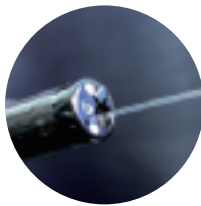

Improved Cleaning and Disinfection

Cleanliness and safety focused on full defense against disinfection.

Easily soiled Air/Water button is removable and autoclavable. A smoother, flatter surface assures all areas receive optimal contact with cleaning and high-performance disinfecting solutions.



Air/Water Button and Suction Button (Autoclavable)

Light-weight Connector

The connectors incorporated in the 500 SERIES SCOPE are slim, lightweight, and easy to handle. Procedures are now considerably less bothersome when the endoscope has to be removed/attached for cleaning and disinfection on every occasion of endoscopy.



Flexible Portion

In upper and lower gastrointestinal endoscopy, the great flexibility of the endoscope allows easy insertability and the comfort of the examinee to coexist, meeting on-the-scene needs.



Fully digital processor 4400 leads the quality of diagnostic imaging to a higher stage.

With the processor and the light source unit employing state-of-the-art digital signal processing, it retains image fineness and precision in picture quality even when viewing microvessels or mucosal surfaces. It also features an HD(High Denition)-compatible processor providing even sharper images with HD signals. On the operation panel are illuminated buttons with pictograms, which are access-friendly during the examination.

EPX-4400 SYSTEM



Upper : XL-4400 Light Source
Bottom : VP-4400 HD Processor

Blood Vessel Enhancement (BLV) Function

Detailed images of vein patterns are useful for advanced diagnosis of alimentary canals. The Blood Vessel Enhancement Function improves the projection and clarity of vein patterns.

(Three steps available by switching)

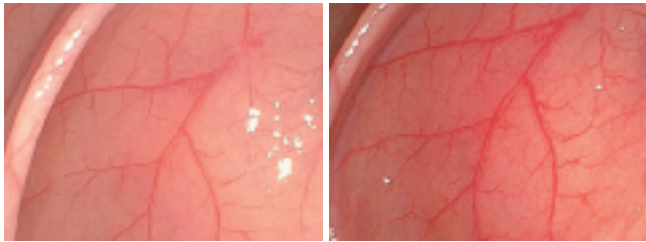

BLV OFF

BLV ON

Integrated Compact Flash Media Card Slot

The CF card slot allows direct recording and reproduction of images in the CF card, a popularly used media. Large-size image files captured with a high-resolution endoscope are stored as digital still images without any deterioration. Images can be transferred to a PC without going through too many steps.



Images captured in a CF card

Image reproduction on a PC

Examination Switch

This newly incorporated switch allows for attachment and removal of the endoscope without turning off the power to the processor unit. After finishing an examination a simple press of the button allows the removal and cleaning of the endoscope while the processor continues to communicate imaging data to the network or Compact Flash card.

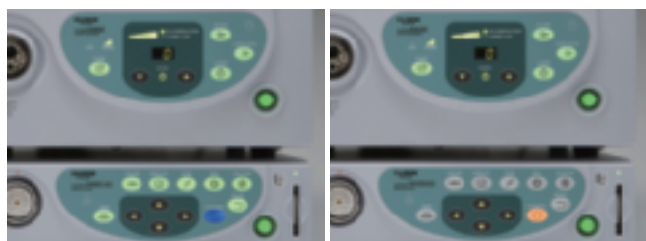

ON

OFF

Automatic Light Control (ALC) Illumination Adjustment Function

The 4400 employs Fujinon's unique new form of automatic light control. This new advanced system reduces light halation and provides images that are easier on the physician's eyes.

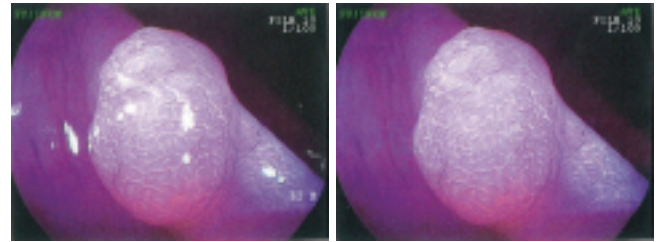

ALC OFF

ALC ON

Internal Image Storage Capacity

The processor incorporates a buffer memory whose capacity is more than enough for images of one examination regardless of compression rates.

It is convenient for quickly reproducing captured images immediately after the examination. Physicians can reproduce images and give instantly a post-examination explanation to the patient, or select required images to be printed.

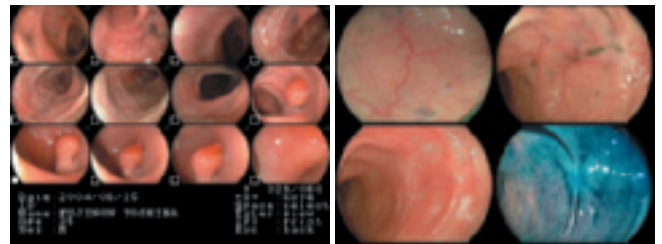

Thumbnail view

Quarter-split view



*The appearance of the cart varies depending on the sales area.

FICE spectral image processing technology widens the potential of endoscopic diagnosis.

Accurate and reliable endoscopic examination and diagnosis require detection of subtle structural and color changes such as elevation, depression, and superficial patterns of lesions.

However, endoscopic images may differ significantly depending on the wavelength of light used for observation.

FICE constructs spectral images from rays having specific wavelengths which are useful for better enhancement of tissue aspects and vessels.

The scope switch allows the physician to switch between conventional image and the FICE image in a split second, ensuring an uninterrupted examination with the eyes always concentrated on the monitor.

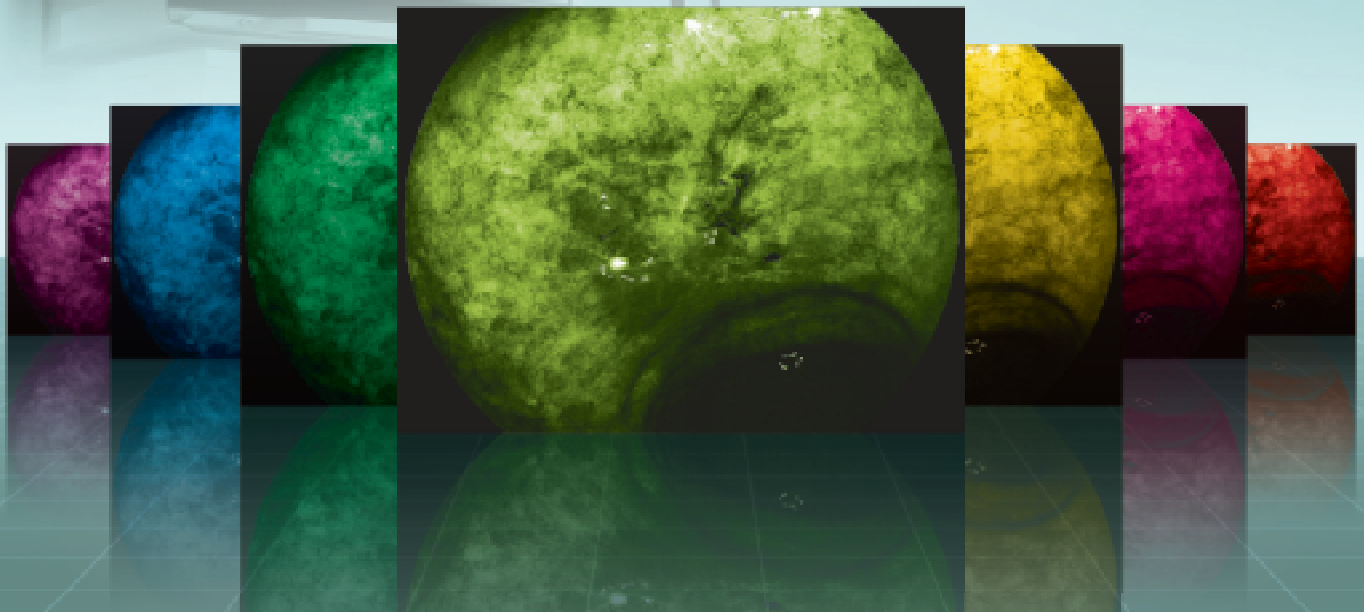
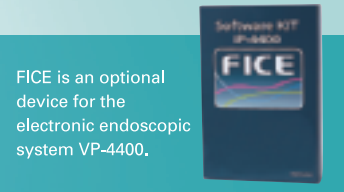

FICE overview

Endoscopes display images on the monitor by directing white light of undulating spectrum (400nm to 700nm) from a xenon lamp onto the tissue and capturing reflected light with a CCD device.

FICE furthermore processes the conventional images into spectral images composed from rays having specific wavelengths and displays them in real-time.

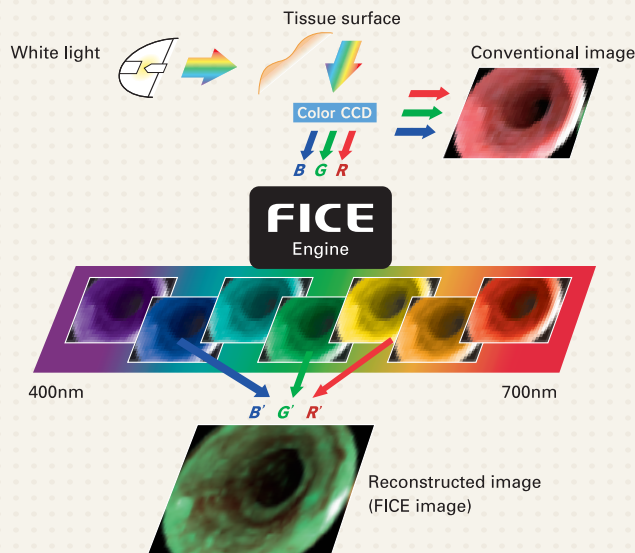

Ten patterns of wavelengths can be preset

FICE has ten preset wavelength patterns that are ready for use in the clinical setting.

Moreover, you can manually alter the preset wavelengths in 5-nm increments and the gain in five steps.

PRESET No.	R (Gain)	G (Gain)	B (Gain)
0	500 (2)	445 (2)	415 (3)
1	500 (2)	470 (2)	420 (3)
2	550 (2)	500 (2)	470 (3)
3	540 (2)	490 (2)	420 (3)
4	520 (2)	500 (2)	405 (3)
5	500 (2)	480 (2)	420 (3)
6	580 (2)	520 (2)	460 (3)
7	520 (2)	450 (2)	400 (3)
8	540 (2)	415 (2)	415 (3)
9	550 (2)	500 (2)	400 (3)

FICE

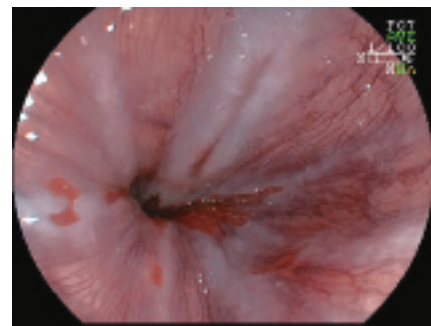

Wavelength (Gain)
R 550(2) **G** 500(2) **B** 470(3)

FICE image sample of a boundary/region examination

Gastric picture

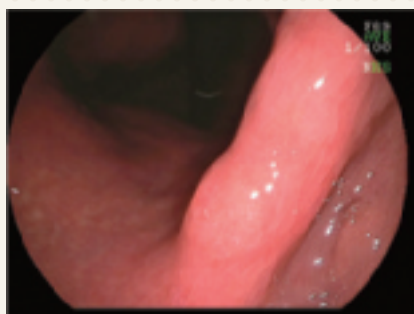

Conventional

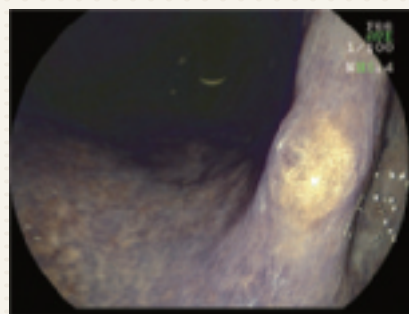

FICE image

Wavelength (Gain)
R 520(2)
G 500(2)
B 405(3)

Two balloons realize better insertability into the depth of digestive tract.

The small intestine has long been the most difficult organ to access in gastrointestinal endoscopy, therefore it has been known as “The Dark Continent.”

With new engineering innovation, Fujinon's Double Balloon Endoscope System designed for the small intestine is equipped with exclusively developed balloons, overtubes and balloon pump controller.

Two balloons improve the insertability of the endoscope into the small intestine.

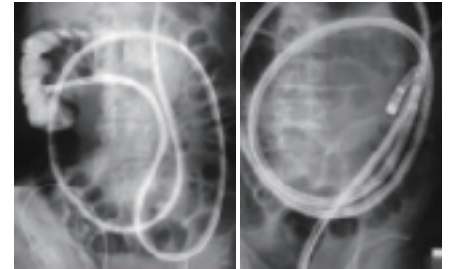

Anterograde Insertion Transanal Insertion

Balloon Pump Controller PB-20

The PB-20 Balloon Pump Controller is designed to simplify operation.

Balloons can be easily controlled via a hand-operated remote control or foot switch - whichever is more convenient for the physician.

Power	AC100V 50/60Hz 0.76A
Power consumption (rated)	0.66A
Set pressure accuracy	±2kPa
Set pressure of balloon	5.6kPa
Maximum flow rate of pump	170ml ± 50ml / 10sec
Dimensions	350(W)×130(H)×420(D)mm
Weight	10kg(Body), 0.4kg(Remote switch)



**DOUBLE BALLOON
ENDOSCOPY**

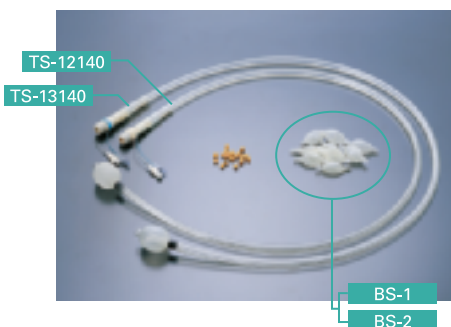

Balloons and Overtubes (Consumable supplies)

The exclusively developed specialized balloons and overtubes ensure complete positioning of the endoscope in the small intestine. In addition, the distal end of the scope can be smoothly inserted to reach the area of diagnosis.

Overtube model	TS-12140	TS-13140	TS-13101
Outer diameter	12.2mm	13.2mm	13.2mm
Total length	1,450mm	1,450mm	950mm
Applicable endoscope	EN-450P5/20	EN-450T5, EN-450T5/W	EC-450BI5

Balloon	BS-1	BS-2
Outer diameter	25mm	35mm

Enteroscope - Standard Type

EN-450P5/20

EN-450P5/20 is an endoscope for the small intestine examination. The relatively slim overtubes (12.2mm outer diameter) of the EN-450P5/20 allow for smooth insertion via both the antegrade and transanal routes depending on the position of lesion.

Viewing direction	0°(Forward)
Field of view	120°
Observation range	5 - 100mm
Distal end diameter	8,5mm
Flexible portion diameter	8.5mm
Bending capability	UP 180° / DOWN 180° RIGHT 160° / LEFT 160°
Working length	2,000mm
Total length	2,300mm
Forceps channel diameter	2.2mm

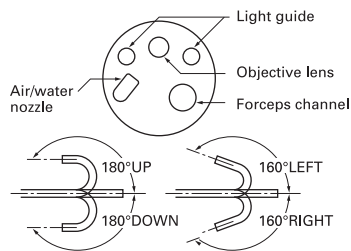
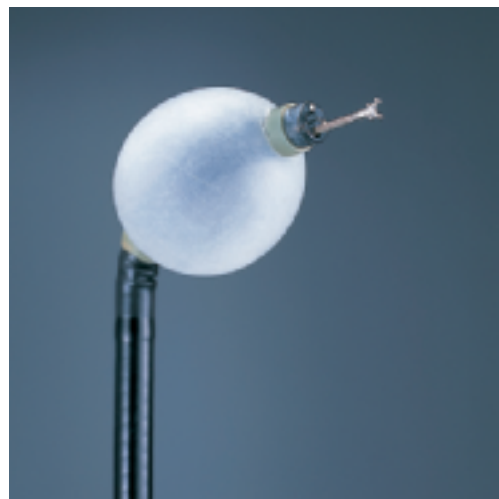

Image area & Forceps entry position



DOUBLE BALLOON



Enteroscope - Treatment Type

EN-450T5, EN-450T5/W

Treatment capacity has been greatly expanded with the EN-450T5 and EN-450T5/W, which are equipped with a 2.8mm forceps channel that allows the use of almost all general therapeutic accessories and a variety of accessories such as APC Probe, Clip, Diathermic Coagulator, and other therapeutic interventions.

	T5	T5/W
Viewing direction	0°(Forward)	
Field of view	140°	
Observation range	4 - 100mm	3 - 100mm
Distal end diameter	9.4mm	
Flexible portion diameter	9.3mm	
Bending capability	UP 180° / DOWN 180° RIGHT 160° / LEFT 160°	
Working length	2,000mm	
Total length	2,300mm	
Forceps channel diameter	2.8mm	

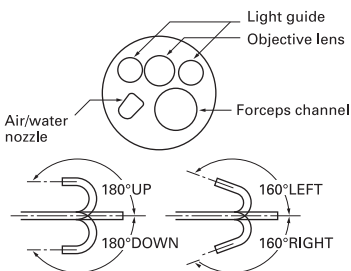

Image area & Forceps entry position



DOUBLE BALLOON FOR TREATMENT



Colonoscope - Standard Type

EC-450BI5

Using balloons, the endoscope is stabilized in the intestinal tract, which leads to better observation and treatment of lesions.

Viewing direction	0°(Forward)
Field of view	140°
Observation range	3 - 100mm
Distal end diameter	9.4mm
Flexible portion diameter	9.3mm
Bending capability	UP 180° / DOWN 180° RIGHT 160° / LEFT 160°
Working length	1,520mm
Total length	1,820mm
Forceps channel diameter	2.8mm

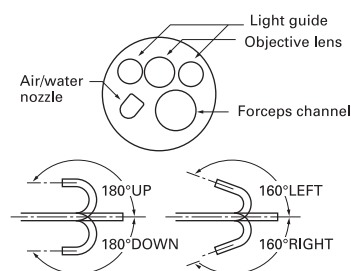

Image area & Forceps entry position



DOUBLE BALLOON



Fujinon's high quality digital imaging enables ideal ultrasonographic diagnosis.

Fujinon has developed endoscopic ultrasonography systems for both radial ultrasound scanning and convex ultrasound scanning which satisfy the most stringent requirements:

"clear image projection" and "excellent usability."

The SU-7000 processor and the EG-530UR and EG-530UT ultrasound endoscopes provide excellent ultrasound endoscopic images.



*The appearance of the cart varies depending on the sales area.

Observation Instrument SU-7000

The SU-7000 allows high-quality ultrasonography to be incorporated with conventional endoscopy into a single cart, resulting in a highly functional, compact system.

Integration of Fujinon's high-performance endoscopy with a state-of-art ultrasonography system allows physicians to make the best use of limited examination space without compromising diagnostic and therapeutic quality.

Endoscopic Ultrasonography



CF (Compact Flash) Media Card Slot

The CF card allows direct recording of images during examination.



Comprehensive Integrated Keyboard

ENDOSCOPE EG-530UR, EG-530UT

EG-530UR and EG-530UT endoscopes combine Fujinon's high-quality endoscope features with the most advanced ultrasound technology, to create an unsurpassed diagnostic and treatment system.

Observation Performance

EG-530UR and EG-530UT have slimmed down distal end and improved bending capabilities as close to those of conventional endoscopes, enabling easier observation in a wider field of view.

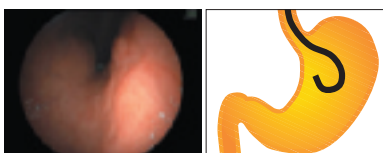

High Resolution Image

For an endoscopic image, our SUPER CCD chip provides high-resolution and high-color, faithfully-reproduced images, which makes it possible to distinguish minute differences in the all-important red spectrum including tiny blood vessels.

For an ultrasonographic image, our original digital image processing optimizes the gradation sequence of images, resulting in providing better ultrasonographic images.



Radial Scan Ultrasound Video Endoscope

EG-530UR

With a slim distal end of 11.4mm and excellent bending capabilities, the EG-530UR allows physicians to perform endoscopic ultrasonography in a similar way to conventional endoscopy. The scope tip bending angle permits observation of previously difficult to access areas.

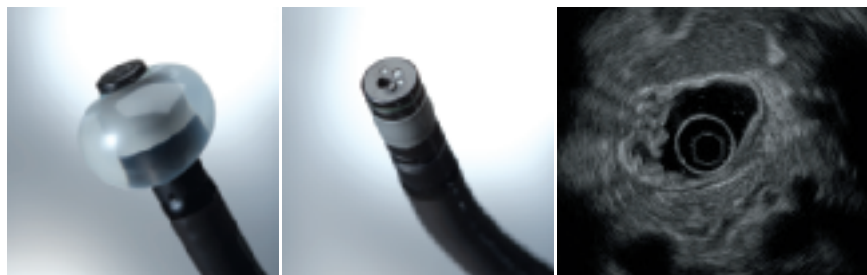

Endoscope Functions

Viewing direction	0°(Forward)
Field of view	140°
Observation range	3 - 100mm
Distal end diameter	11.4mm
Flexible portion diameter	11.5mm
Bending capability	UP 180° / DOWN 90° RIGHT 100° / LEFT 100°
Working length	1,250mm
Total length	1,550mm
Forceps channel diameter	2.2mm

Ultrasonic Functions

Scanning mode	Color Doppler / Power Doppler / PW Doppler / B mode / M mode / THI
Scanning method	Electronic radial
Scanning area	360°
Frequency	5MHz / 7.5MHz / 10MHz / 12MHz
Contact Method	Balloon method / degassed water congestion method / contacting method

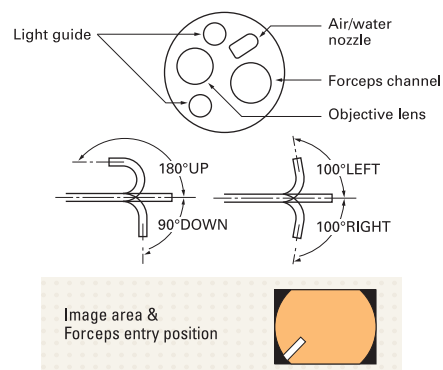

Convex Scan Ultrasound Video Endoscope

EG-530UT

With its forceps channel elevator function, the distal end of EG-530UT improves the injection performance of the puncture needle. It also has a large channel which enables various treatment accessories to be inserted. With excellent bending capabilities, the EG-530UT provides better access to lesions and greater flexibility in treatment.

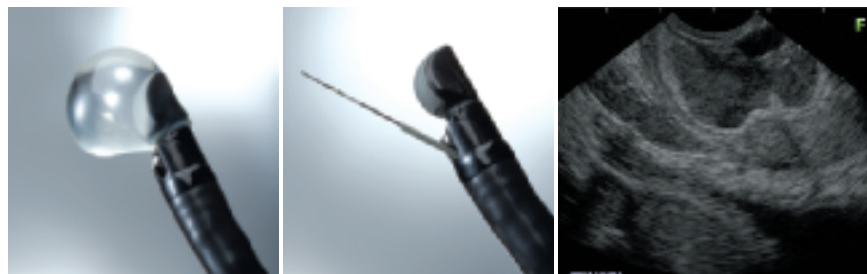

Endoscope Functions

Viewing direction	Forward oblique 40°
Field of view	140°
Observation range	3 - 100mm
Distal end diameter	13.9mm
Flexible portion diameter	12.1mm
Bending capability	UP 160° / DOWN 160° RIGHT 120° / LEFT 120°
Working length	1,250mm
Total length	1,550mm
Forceps channel diameter	3.8mm

Ultrasonic Functions

Scanning mode	Color Doppler / Power Doppler / PW Doppler / B mode / M mode / THI
Scanning method	Electronic convex
Scanning area	110°
Frequency	5MHz / 7.5MHz / 10MHz / 12MHz
Contact Method	Balloon method / degassed water congestion method / contacting method

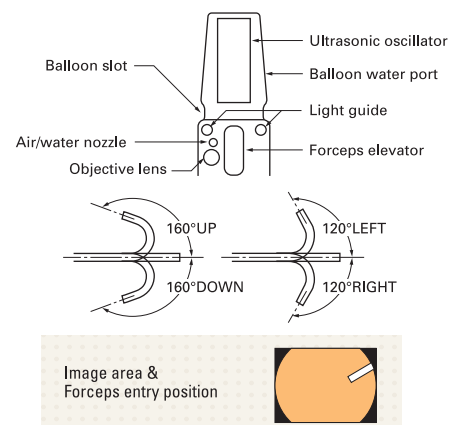

High Quality Image Endoscopes

Super CCD equipped Electronic Endoscopes

Using the progressive scan method which prevents deteriorated resolution, the SUPER CCD captures still images in high definition.

The images have little chromatic noise and appear as real images even when the screen is frozen.

The SUPER CCD provides not just high-resolution images, but using the RGB filtering capability, it also provides vivid colors in the red spectrum which are important in endoscopic diagnosis.

It is a high-quality endoscope born in the digital imaging era.



Using Progressive Scan Method

Fujinon's SUPER CCD captures the high-quality images. The quality of images taken by SUPER CCD is one rank higher than the images from conventional high-quality endoscopes, which enables easier detection of minute lesions.

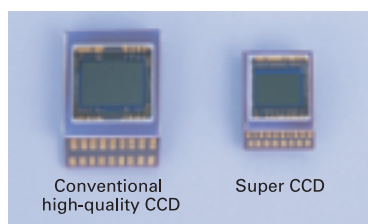

SUPER CCD 590 SERIES ENDOSCOPE

For the Upper G.I. Tract - Optical Magnification

EG-590ZW

EG-590ZW is a high quality optical magnifying electronic endoscope for the upper G.I. tract. The optical magnification enhances the images for easier and closer observation. This endoscope has maximum optical magnification levels of up to 135 times when viewed on a 19 inch monitor and also an excellent field of view.

Viewing direction	0°(Forward)
Field of view	WD:140° / TL:55°
Observation range	WD:6 - 100mm / TL:2 - 3mm
Distal end diameter	10.8mm
Flexible portion diameter	9.8mm
Bending capability	UP 210° / DOWN 90° RIGHT 100° / LEFT 100°
Working length	1,100mm
Total length	1,400mm
Forceps channel diameter	2.8mm

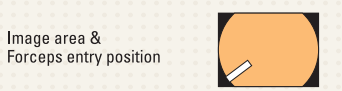
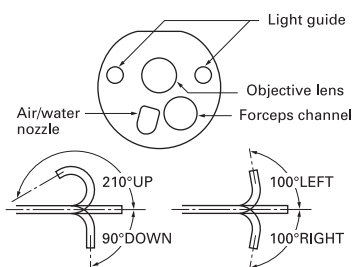

OPTICAL
MAGNIFYING

WIDE VIEW

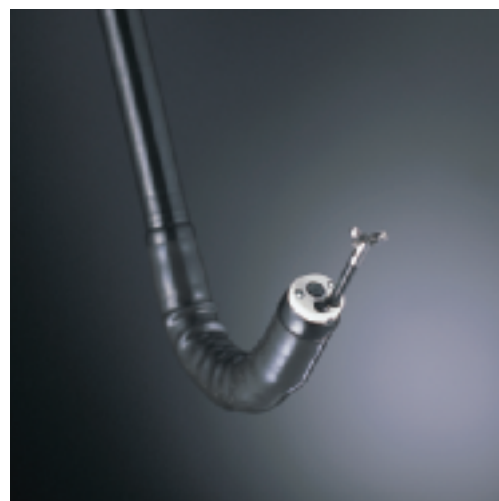

For the Upper G.I. Tract - Standard Type

EG-590WR

This endoscope is reasonably slim with a distal end of 9.6mm, yet is equipped with adequate functions necessary for routine examinations. This is a high-definition standard endoscope. The air/water nozzle is redesigned to constantly secure a clear field of view, and its water filtering function is significantly improved.

Viewing direction	0°(Forward)
Field of view	140°
Observation range	6 - 100mm
Distal end diameter	9.6mm
Flexible portion diameter	9.3mm
Bending capability	UP 210° / DOWN 90° RIGHT 100° / LEFT 100°
Working length	1,100mm
Total length	1,400mm
Forceps channel diameter	2.8mm

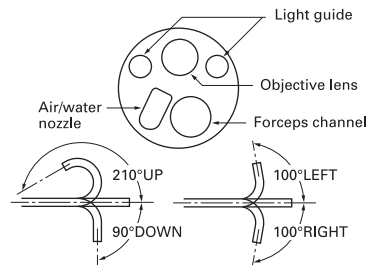

Image area & Forceps entry position



WIDE VIEW



For the Lower G.I. Tract - Optical Magnification

EC-590ZW/M, EC-590ZW/L

These optical magnifying endoscopes for the lower G.I. tract have a water jet function which is effective for washing off mucus and securing a better field of view. This endoscope has a wide variety of functions such as a large 3.8mm forceps channel, optical magnifying function and water jet function.

	ZW/M	ZW/L
Viewing direction	0°(Forward)	
Field of view	WD:140° / TL:55°	
Observation range	WD:6 - 100mm / TL:2 - 3mm	
Distal end diameter	12.8mm	
Flexible portion diameter	12.8mm	
Bending capability	UP 180° / DOWN 180° RIGHT 160° / LEFT 160°	
Working length	1,330mm	1,690mm
Total length	1,630mm	1,990mm
Forceps channel diameter	3.8mm	

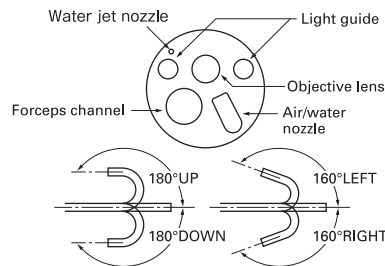

Image area & Forceps entry position



WATER JET

OPTICAL MAGNIFYING

WIDE VIEW



For the Lower G.I. Tract - Standard Type

EC-590WM, EC-590WI, EC-590WL

These endoscopes for the lower G.I. tract routine examinations have an ultra wide 140° field of view, a large 3.8mm channel and also a water jet function which is effective for washing off mucus.

	WM	WI	WL
Viewing direction	0°(Forward)		
Field of view	140°		
Observation range	3 - 100mm		
Distal end diameter	12.8mm		
Flexible portion diameter	12.8mm		
Bending capability	UP 180° / DOWN 180° RIGHT 160° / LEFT 160°		
Working length	1,330mm	1,520mm	1,690mm
Total length	1,630mm	1,820mm	1,990mm
Forceps channel diameter	3.8mm		

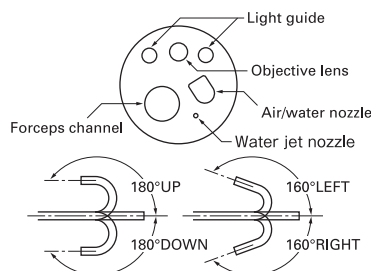

Image area & Forceps entry position



WATER JET

WIDE VIEW



High quality 530 Series Endoscope covers screening, diagnosis and treatment.

530 Series Endoscope features high quality endoscopes which serve various kinds of examination and diagnosis. Transnasal endoscope that is easy for the examinees, multi-purpose endoscope for various purposes, and lower G.I. endoscope with a large channel and strong suction power — these are among many scopes available to choose from depending on the examination purpose.

530 SERIES ENDOSCOPE



For the Upper G.I.Tract - Transnasal Type

EG-530N

Fujinon's own micro precision processing technology slimmed down the distal end diameter to 5.9mm and facilitates insertion through the nose. Being ultrafine, EG-530N fulfills all requirements for G.I. endoscopy such as 4-way angulation, forceps channel, and two lights to eliminate shadows.

Viewing direction	0°(Forward)
Field of view	120°
Observation range	3 - 100mm
Distal end diameter	5.9mm
Flexible portion diameter	5.9mm
Bending capability	UP 210° / DOWN 90° RIGHT 100° / LEFT 100°
Working length	1,100mm
Total length	1,400mm
Forceps channel diameter	2.0mm

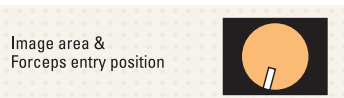
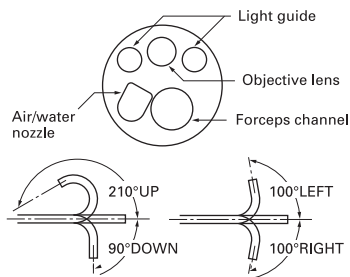

TRANSNASAL ULTRA SLIM 5.9 mm LIGHT-WEIGHT CONNECTOR

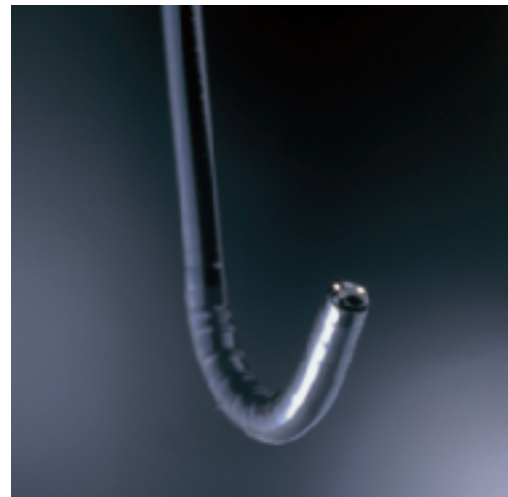

For the Upper G.I.Tract - Transnasal Type

EG-530NP

EG-530NP slimmed down its scope to the utmost and realized a 4.9mm distal end (5.1mm in the flexible portion), immensely improving the transnasal insertion capability. This transnasal endoscope is also equipped with dual light guides and a 2.0mm forceps channel.

* This endoscope is not compatible with high-frequency treatment.

Viewing direction	0°(Forward)
Field of view	120°
Observation range	3 - 100mm
Distal end diameter	4.9mm
Flexible portion diameter	5.1mm
Bending capability	UP 210° / DOWN 120°
Working length	1,100mm
Total length	1,460mm
Forceps channel diameter	2.0mm

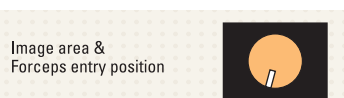
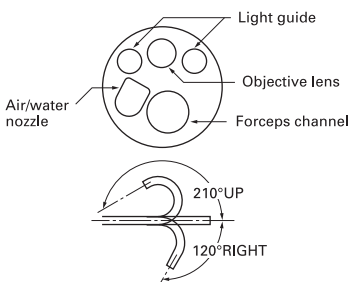

TRANSNASAL ULTRA SLIM 4.9 mm



For the Upper G.I.Tract - Standard Type

EG-530WR

The EG-530WR uses SUPER IMAGE of a wide field of view of 140° and Fujinon's traditional 410k CCD chip to provide exceptional visualization. With the forceps channel of 2.8mm, it is a standard endoscope producing high quality images, which is highly suited for biopsies and treatment.

Viewing direction	0°(Forward)
Field of view	140°
Observation range	4 - 100mm
Distal end diameter	9.4mm
Flexible portion diameter	9.3mm
Bending capability	UP 210° / DOWN 90° RIGHT 100° / LEFT 100°
Working length	1,100mm
Total length	1,400mm
Forceps channel diameter	2.8mm

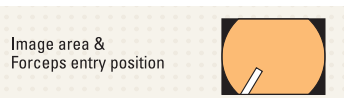
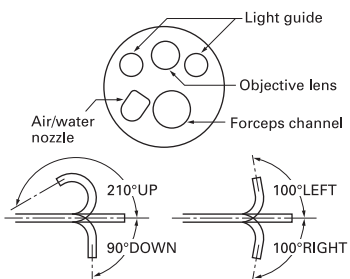

410K CCD WIDE VIEW LIGHT-WEIGHT CONNECTOR

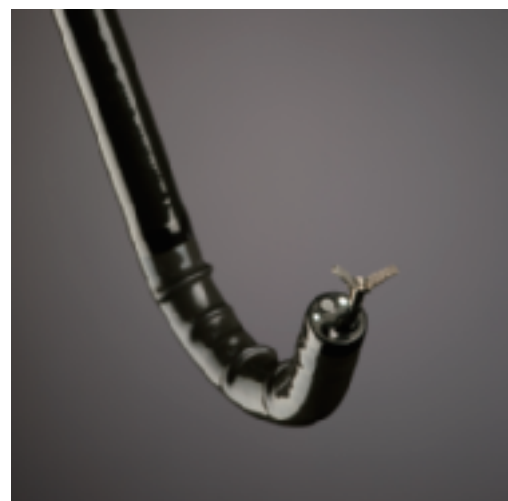

For the Upper G.I.Tract - Slim Type

EG-530FP

EG-530FP is a slim endoscope for the upper G.I. tract having a forceps channel of 2.8mm diameter and a distal end of 8.5mm.

Observation capability has been increased with a wide field of view of 140° and Fujinon's Super CCD technology.

Viewing direction	0°(Forward)
Field of view	140°
Observation range	3 - 100mm
Distal end diameter	8.5mm
Flexible portion diameter	8.5mm
Bending capability	UP 210° / DOWN 90° RIGHT 100° / LEFT 100°
Working length	1,100mm
Total length	1,400mm
Forceps channel diameter	2.8mm

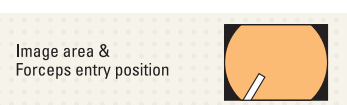
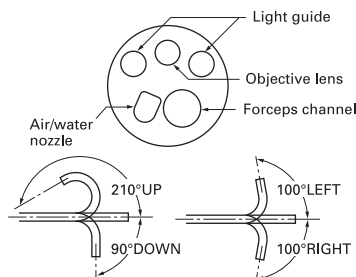

SLIM 8.5mm WIDE VIEW LIGHT-WEIGHT CONNECTOR SUPER CCD



For the Upper G.I.Tract - Treatment Type

EG-530CT

With the forceps channel as wide as 3.8mm, EG-530CT's distal end is as slim as 10.8mm in diameter. Water jet function is also incorporated for removing mucus.

Viewing direction	0°(Forward)
Field of view	140°
Observation range	3 - 100mm
Distal end diameter	10.8mm
Flexible portion diameter	10.8mm
Bending capability	UP 210° / DOWN 90° RIGHT 100° / LEFT 100°
Working length	1,100mm
Total length	1,400mm
Forceps channel diameter	3.8mm

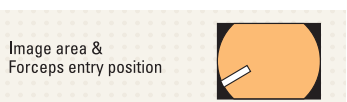
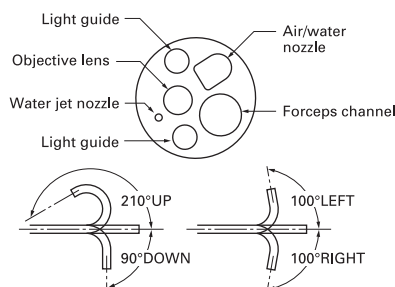

BIG CHANNEL 410K CCD WIDE VIEW WATER JET



For the Upper G.I.Tract - Treatment Type

EG-530D

EG-530D is an endoscope for treatment of the upper G.I. tract, having two forceps channels, 3.8mm and 2.8mm, and a distal end as slim as 11.5mm. Water jet function is also incorporated for various treatment methods during endoscopy.

Viewing direction	0°(Forward)
Field of view	140°
Observation range	3 - 100mm
Distal end diameter	11.5mm
Flexible portion diameter	11.5mm
Bending capability	UP 210° / DOWN 90° RIGHT 100° / LEFT 100°
Working length	1,090mm
Total length	1,405mm
Forceps channel diameter	3.8mm / 2.8mm

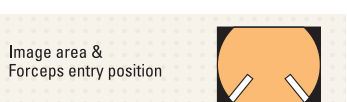
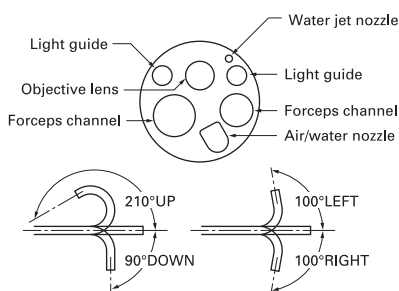

DUAL CHANNEL 410K CCD WIDE VIEW WATER JET



For the Duodenum

ED-530XT, ED-530XT8

BIG CHANNEL

The structure of the distal end, bending portion and flexible portion is changed for improved maneuverability during examination and treatment.

Viewing direction	98°(8°rearward)
Field of view	100°
Observation range	4 - 60mm
Distal end diameter	13.1mm
Flexible portion diameter	11.5mm
Bending capability	UP 130° / DOWN 90° RIGHT 110° / LEFT 90°
Working length	1,250mm
Total length	1,550mm
Forceps channel diameter	4.2mm

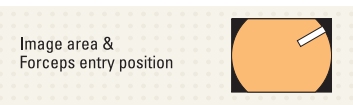
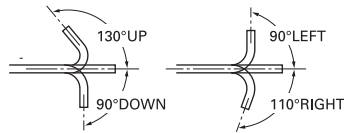
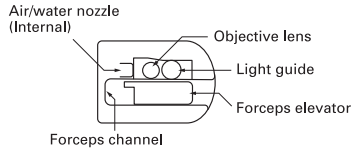

The distal end of the ED-530XT8 is covered with a removable cap. The forceps elevator mechanism built in the distal end of the ED-530XT8 is airproof, keeping it free from contamination.

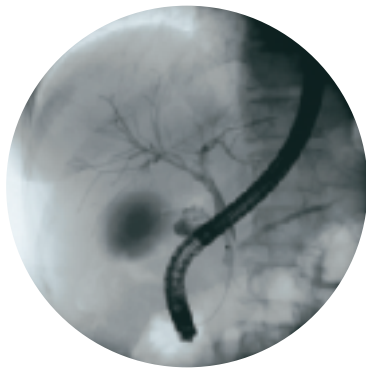

530 SERIES LOWER GASTROINTESTINAL ENDOSCOPES

For the Lower G.I.Tract - Standard Type

EC-530WM, EC-530WI, EC-530WL

410K CCD WIDE VIEW WATER JET

With a wide field of view of 140°, these lower G.I. tract endoscopes have a greater resolution at the image edges. Flexible inserted portion and operation portion with light-weight grip facilitates insertion.

	WM	WI	WL
Viewing direction	0°(Forward)		
Field of view	140°		
Observation range	3 - 100mm		
Distal end diameter	12.8mm		
Flexible portion diameter	12.8mm		
Bending capability	UP 180° / DOWN 180° RIGHT 160° / LEFT 160°		
Working length	1,330mm	1,520mm	1,690mm
Total length	1,630mm	1,820mm	1,990mm
Forceps channel diameter	3.8mm		

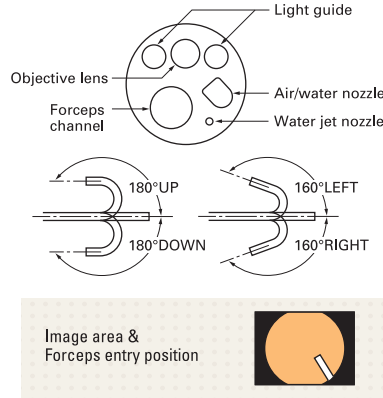

For the Lower G.I.Tract - Treatment Type

EC-530MT, EC-530IT, EC-530LT

BIG CHANNEL 410K CCD WIDE VIEW WATER JET

With a large channel of 4.2mm accommodating various treatment accessories, these lower G.I. tract endoscopes are suited for examination and treatment, which also have a rapid suction function.

	MT	IT	LT
Viewing direction	0°(Forward)		
Field of view	140°		
Observation range	3 - 100mm		
Distal end diameter	12.8mm		
Flexible portion diameter	12.8mm		
Bending capability	UP 180° / DOWN 180° RIGHT 160° / LEFT 160°		
Working length	1,330mm	1,520mm	1,690mm
Total length	1,630mm	1,820mm	1,990mm
Forceps channel diameter	4.2mm		

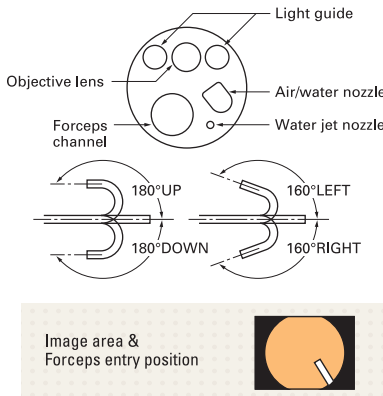

For the Lower G.I.Tract - Slim Type

EC-530MP, EC-530LP

SLIM 11.0 mm 410K CCD WIDE VIEW

These are slim-type endoscopes for lower G.I. tract with the distal end of 11.0mm. While these two slimmed-down scopes have improved insertability, they retain a 3.2mm forceps channel to accommodate various treatment methods.

	MP	LP
Viewing direction	0°(Forward)	
Field of view	140°	
Observation range	3 - 100mm	
Distal end diameter	11.0mm	
Flexible portion diameter	11.1mm	
Bending capability	UP 180° / DOWN 180° RIGHT 160° / LEFT 160°	
Working length	1,330mm	1,690mm
Total length	1,630mm	1,990mm
Forceps channel diameter	3.2mm	

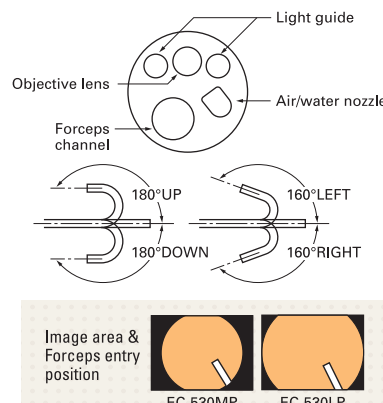

For the Lower G.I. Tract - Treatment Type EC-530DM, EC-530DL

These lower G.I. tract endoscopes have two forceps channels (3.8mm and 2.8mm), especially useful for treatment during endoscopy such as EMR.

	DM	DL
Viewing direction	0°(Forward)	
Field of view	140°	
Observation range	3 - 100mm	
Distal end diameter	12.8mm	
Flexible portion diameter	12.8mm	
Bending capability	UP 180° / DOWN 180° RIGHT 160° / LEFT 160°	
Working length	1,330mm	1,690mm
Total length	1,645mm	2,005mm
Forceps channel diameter	3.8mm/2.8mm	

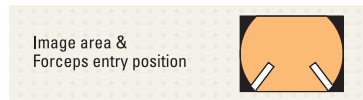
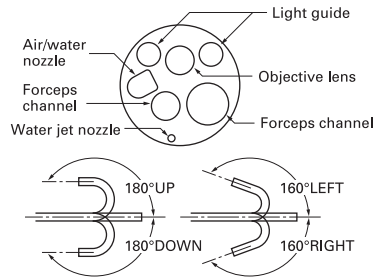

DUAL CHANNEL 410K CCD WIDE VIEW WATER JET



For the Lower G.I. Tract - Standard Type EC-530FM/EC-530FI/EC-530FL

These super wide-angle standard colonoscopes offer a large 3.8mm working channel inside a slim 12.8mm outside diameter. An ultra-wide 140 degree field of view enhances image quality from the center to the edge. These colonoscopes also offer a wider observation range from 3-100mm. In addition, an integrated forward water jet allows for lavage in clinical situations.

	FM	FI	FL
Viewing direction	0°(Forward)		
Field of view	140°		
Observation range	3 - 100mm		
Distal end diameter	12.8mm		
Flexible portion diameter	12.8mm		
Bending capability	UP 180° / DOWN 180° RIGHT 160° / LEFT 160°		
Working length	1,330mm	1,520mm	1,690mm
Total length	1,630mm	1,820mm	1,990mm
Forceps channel diameter	3.8mm		

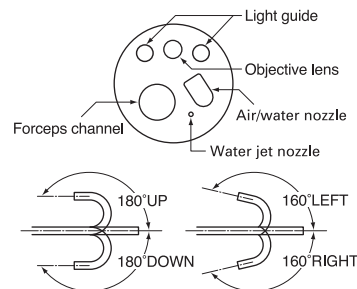

WIDE VIEW WATER JET LIGHT-WEIGHT CONNECTOR



For the Lower G.I. Tract - Sigmoidoscope ES-530WE

ES-530WE is a sigmoidoscope of an effective length of 790mm. The forceps channel diameter is 3.8mm, and is equipped with water jet function.

Viewing direction	0°(Forward)
Field of view	140°
Observation range	3 - 100mm
Distal end diameter	12.8mm
Flexible portion diameter	12.8mm
Bending capability	UP 180° / DOWN 180° RIGHT 160° / LEFT 160°
Working length	790mm
Total length	1,090mm
Forceps channel diameter	3.8mm

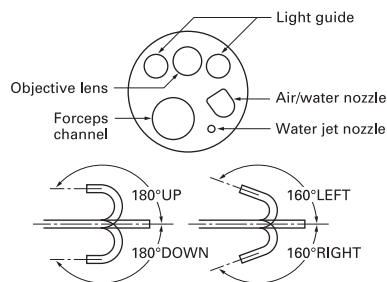

410K CCD WIDE VIEW WATER JET



EXAMPLE OF SYSTEM CONFIGURATION

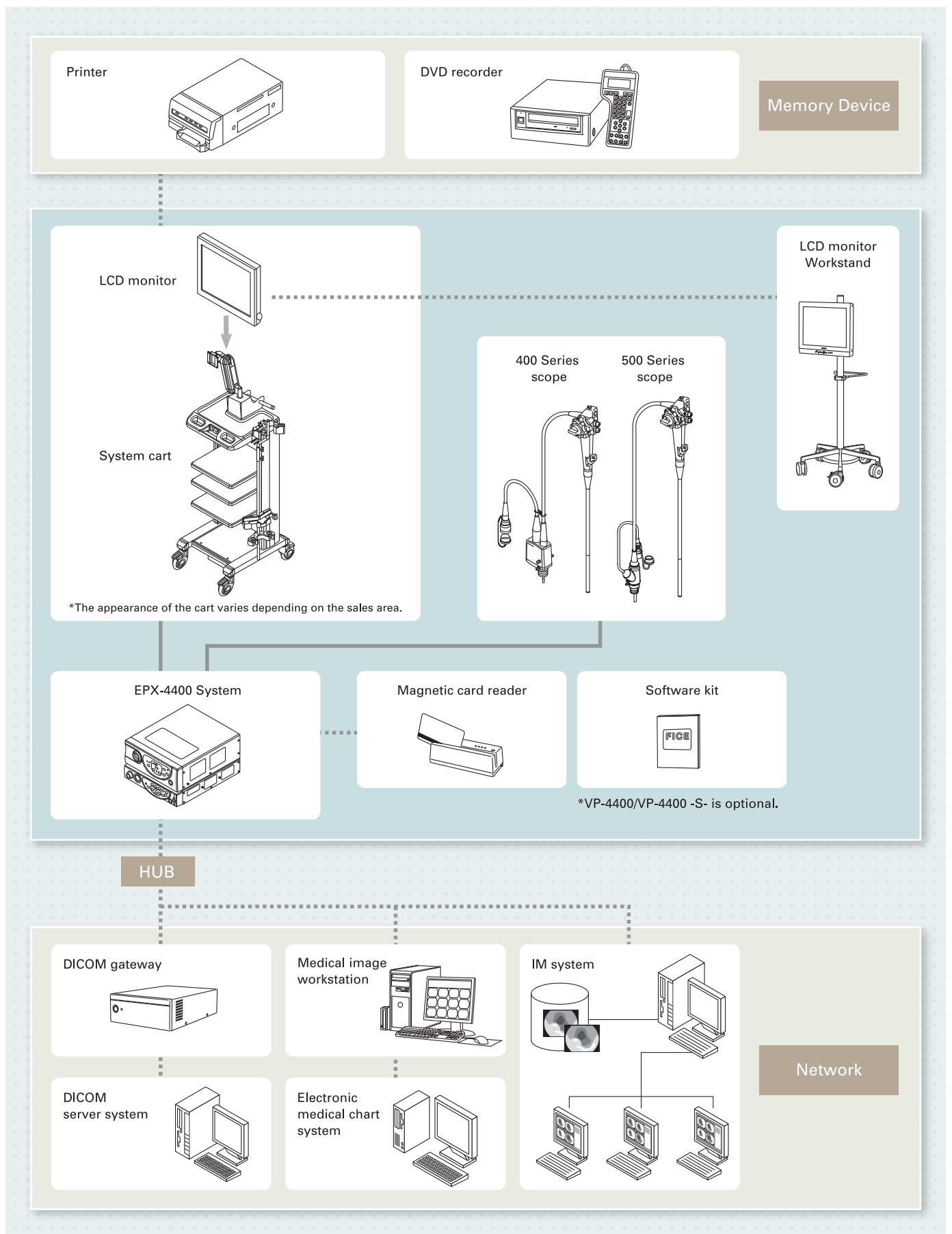



Upper : Light Source XL-4400
 Bottom : Processor VP-4400

Light Source

	XL-4400 (120V)	XL-4400 -S- (230V)	XL-4400HD (120V)	XL-4400 -HD- (230V)
Lamp	300W short-arc Xenon lamp (Emergency lamp : 75W Halogen lamp)			
Main specifications	Automatic light control Air supply pump Nomal / Low / OFF			
Power	AC120V 60Hz 3.7A	AC230V 50Hz 1.9A	AC120V 60Hz 3.7A	AC230V 50Hz 1.9A
Dimensions	350(W)×420(D)×130(H) mm			
Weight	17 kg			

Processor

	VP-4400 (120V)	VP-4400 -S- (230V)	VP-4400HD (120V)	VP-4400 -HD- (230V)
Image output signal				
[Digital outputs]				
DVI (Digital Visual Interface) LCD Monitor	1	1	1	1
HD-SDI	—	—	2	2
IEEE-1394 VTR interface	1	1	1	1
Network interface 100/10 Base	1	1	1	1
[Analog outputs]				
RGB	1	1	1	1
RGB (TV/PC changeover)	2	2	2	2
VBS	1	1	1	1
S-Video	1	1	1	1
Control signals				
RS-232C terminal	2	2	2	2
Card reader terminal	1	1	1	1
Remote (trigger output)	3	3	3	3
Main functions				
Electronic shutter	1/30, 1/60, 1/100, 1/200, 1/400, AUTO			
Electronic image zoom	ratio of 1.05 to 2.0			
Examination switch	ON / OFF			
Image recording media	CF card			
Noise reduction	ON / OFF			
Blood vessel enhancement	ON / OFF			
Internal image storage capacity	152 frames (60 frames in the 590 series)			
IRIS mode	Average / Peak changeover			
Power	AC120V 60 Hz 0.31A	AC230V 50Hz 0.17A	AC120V 60Hz 0.35A	AC230V 50Hz 0.21A
Dimensions	350(W)×420(D)×75(H) mm (excluding projections)			
Weight	8 kg	8 kg	9kg	9kg

FUJIFILM

FUJIFILM Corporation

26-30, NISHIAZABU 2-CHOME, MINATO-KU, TOKYO 106-8620, JAPAN
<http://www.fujifilm.com/products/medical/endoscopy/contact/>

SGE-100-03 Printed in Japan 201009-FP(OP)